



宇华国际科技有限公司
YuHua INT,L Technology Co., LIMITED

**SPECIFICATION
FOR
LCD MODULE**

Customer : _____
Product Model: YH070SS4001
Sample code: _____

Designed by	Checked by	Approved by

Final Approval by Customer

<input type="checkbox"/> LCM Machinery OK Checked By _____ <input type="checkbox"/> LCM Display OK Checked By _____	<input type="checkbox"/> LCM OK <input type="checkbox"/> NG , Problem survey: Approved By _____
--	---

※The specification of "TBD" should refer to the measured value of sample . If there is difference between the design specification and measured value, we naturally shall negotiate and agree to solution with customer.

Contents

1. General Specifications	1
2. Pin Assignment	2
3. Operation Specifications	5
3.1. Absolute Maximum Ratings	5
3.1.1. Typical Operation Conditions	6
3.1.2. Current Consumption	7
3.1.3. Backlight Driving Conditions	7
3.2. Power Sequence	8
3.3. Timing Characteristics	9
3.3.1. AC Electrical Characteristics	9
3.3.2. Input Clock and Data Timing Diagram	9
3.3.3. DC Electrical Characteristics	10
3.3.4. Timing	11
3.3.5. Data Input Format	12
4. Optical Specifications	13
5. Reliability Test Items	17
6. General Precautions	18
6.1. Safety	18
6.2. Handling	18
6.3. Static Electricity	18
6.4. Storage	18
6.5. Cleaning	18
7. Mechanical Drawing	19
8. Package Drawing	20
8.1. Packaging Material Table	20
8.2. Packaging Quantity	20
8.3. Packaging Drawing	21

1. General Specifications

No.	Item	Specification	Remark
1	LCD size	7.0 inch(Diagonal)	
2	Driver element	a-Si TFT active matrix	
3	Resolution	1024 × 3(RGB) × 600	
4	Display mode	Normally White, Transmissive	
5	Dot pitch	0.05(W) × 0.15(H) mm	
6	Active area	153.6(W) × 90.0(H) mm	
7	Module size	165.75 (W) × 105.39(H) × 2.8(D) mm	Note 1
8	Surface treatment	Plant, Glare	
9	Color arrangement	RGB-stripe	
10	Interface	Digital	
11	View direction(Gray Inversion)	6 O'Clock	
12	Backlight power consumption	1.6W (Typ.)	
13	Panel power consumption	0.35W (Typ.)	
14	Weight	TBD(Typ.)	

Note 1: Refer to Mechanical Drawing.

2. Pin Assignment

FPC Connector is used for the module electronics interface. The recommended model is FH12A-40S-0.5SH manufactured by Hirose.

Pin No.	Symbol	I/O	Function	Remark
1	VCOM	P	Common Voltage	
2	VDD	P	Power Voltage for digital circuit	
3	VDD	P	Power Voltage for digital circuit	
4	NC	---	No connection	
5	Reset	I	Global reset pin	
6	STBYB	I	Standby mode, Normally pulled high STBYB = "1", normal operation STBYB = "0", timing controller, source driver will turn off, all output are High-Z	
7	GND	P	Ground	
8	RXIN0-	I	- LVDS differential data input	
9	RXIN0+	I	+ LVDS differential data input	
10	GND	P	Ground	
11	RXIN1-	I	- LVDS differential data input	
12	RXIN1+	I	+ LVDS differential data input	
13	GND	P	Ground	
14	RXIN2-	I	- LVDS differential data input	
15	RXIN2+	I	+ LVDS differential data input	
16	GND	P	Ground	
17	RXCLKIN-	I	- LVDS differential clock input	
18	RXCLKIN+	I	+ LVDS differential clock input	
19	GND	P	Ground	
20	RXIN3-	I	- LVDS differential data input	
21	RXIN3+	I	+ LVDS differential data input	
22	GND	P	Ground	
23	NC	---	No connection	
24	NC	---	No connection	
25	GND	P	Ground	
26	NC	---	No connection	

27	DIMO	O	Backlight CABC controller signal output	
28	SELB	I	6bit/8bit mode select	Note1
29	AVDD	P	Power for Analog Circuit	
30	GND	P	Ground	
31	LED-	P	LED Cathode	
32	LED-	P	LED Cathode	
33	L/R	I	Horizontal inversion	Note3
34	U/D	I	Vertical inversion	Note3
35	VGL	P	Gate OFF Voltage	
36	CABCEN1	I	CABC H/W enable	Note2
37	CABCEN0	I	CABC H/W enable	Note2
38	VGH	P	Gate ON Voltage	
39	LED+	P	LED Anode	
40	LED+	P	LED Anode	

I: input, O: output, P: Power

Note1: If LVDS input data is 6 bits ,SELB must be set to High;

If LVDS input data is 8 bits ,SELB must be set to Low.

Note2: When CABC_EN="00", CABC OFF.

When CABC_EN="01", user interface image.

When CABC_EN="10", still picture.

When CABC_EN="11", moving image.

When CABC off, don't connect DIMO, else connect it to backlight.

Note3: When L/R="0", set right to left scan direction.

When L/R="1", set left to right scan direction.

When U/D="0", set top to bottom scan direction.

When U/D="1", set bottom to top scan direction.

Note: Definition of scanning direction.
Refer to the figure as below:

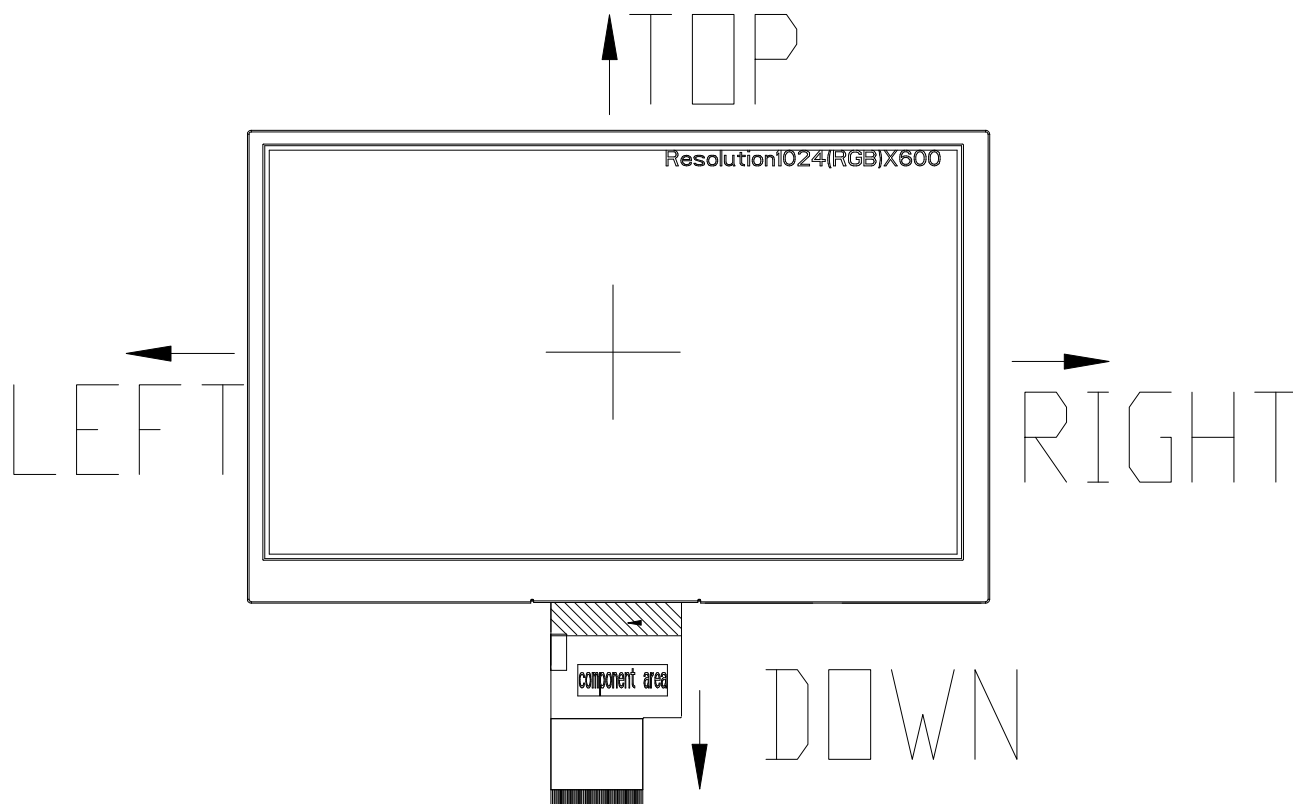

3. Operation Specifications

3.1. Absolute Maximum Ratings

(Note 1)

Item	Symbol	Values		Unit	Remark
		Min.	Max.		
Power voltage	DV_{DD}	-0.3	5.0	V	
	AV_{DD}	6.5	13.5	V	
	V_{GH}	-0.3	42.0	V	
	V_{GL}	-20.0	0.3	V	
	$V_{GH}-V_{GL}$	-	40.0	V	
Operation Temperature	T_{OP}	-20	60	°C	
Storage Temperature	T_{ST}	-30	70	°C	
LED Reverse Voltage	V_R	-	5	V	Each LED
LED Forward Current	I_F	-	35	mA	Each LED

Note 1: The absolute maximum rating values of this product are not allowed to be exceeded at any times. Should a module be used with any of the absolute maximum ratings exceeded, the characteristics of the module may not be recovered, or in an extreme case, the module may be permanently destroyed.

3.1.1. Typical Operation Conditions

(Note 1)

Item	Symbol	Values			Unit	Remark
		Min.	Typ.	Max.		
Power voltage	DV_{DD}	3.0	3.3	3.6	V	Note 2
	AV_{DD}	10.8	11	11.2	V	
	V_{GH}	19.7	20	20.3	V	
	V_{GL}	-6.5	-6.8	-7.1	V	
Input signal voltage	V_{COM}	2.7	(3.7)	4.7	V	Note 4
Input logic high voltage	V_{IH}	$0.7 DV_{DD}$	-	DV_{DD}	V	Note 3
Input logic low voltage	V_{IL}	0	-	$0.3 DV_{DD}$	V	

Note 1: Be sure to apply DV_{DD} and V_{GL} to the LCD first, and then apply V_{GH} .

Note 2: DV_{DD} setting should match the signals output voltage (refer to Note 3) of customer's system board.

Note 3: LVDS, Reset.

Note 4: Typ. V_{COM} is only a reference value, it must be optimized according to each LCM. Be sure to use VR;

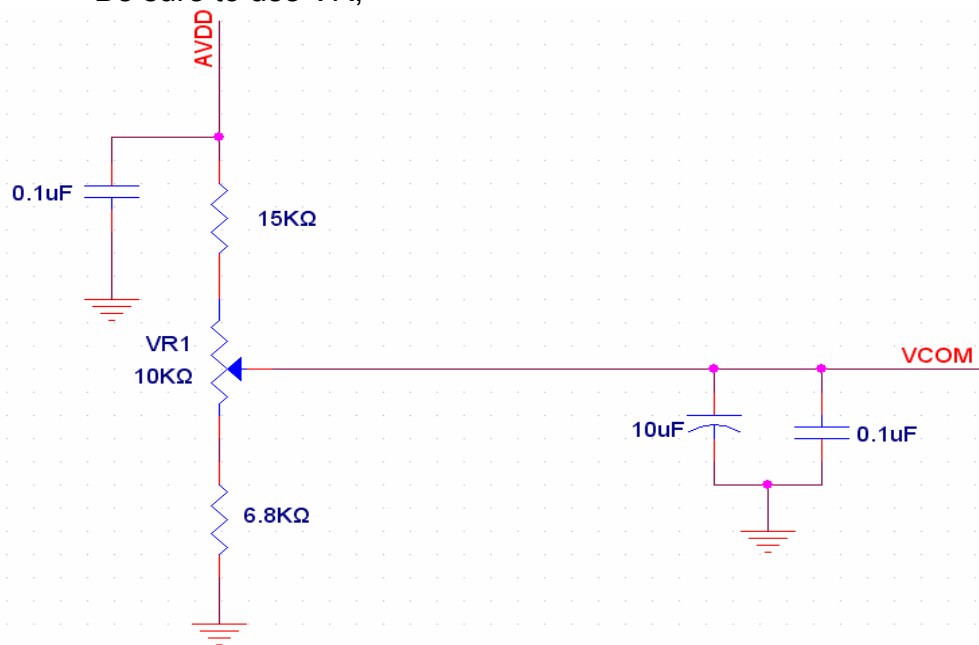

3.1.2. Current Consumption

Item	Symbol	Values			Unit	Remark
		Min.	Typ.	Max.		
Current for Driver	I_{GH}	-	0.25	1.0	mA	$V_{GH} = 20V$
	I_{GL}	-	0.25	1.0	mA	$V_{GL} = -6.8V$
	IDV_{DD}	-	38	60	mA	$DV_{DD} = 3.3V$
	$I_{AV_{DD}}$	-	20	30	mA	$AV_{DD} = 11V$

3.1.3. Backlight Driving Conditions

Item	Symbol	Values			Unit	Remark
		Min.	Typ.	Max.		
Voltage for LED backlight	V_L	--	9.3	10.2	V	Note 1
Current for LED backlight	I_L	--	160	200	mA	
LED life time	-	-	20,000	-	Hr	Note 2

Note 1: The LED Supply Voltage is defined by the number of LED at $T_a = 25^\circ C$ and $I_L = 160mA$.

Note 2: The "LED life time" is defined as the module brightness decrease to 50% original brightness at $T_a = 25^\circ C$ and $I_L = 160mA$. The LED lifetime could be decreased if operating I_L is larger than 160mA.

3.2. Power Sequence

a. Power on:

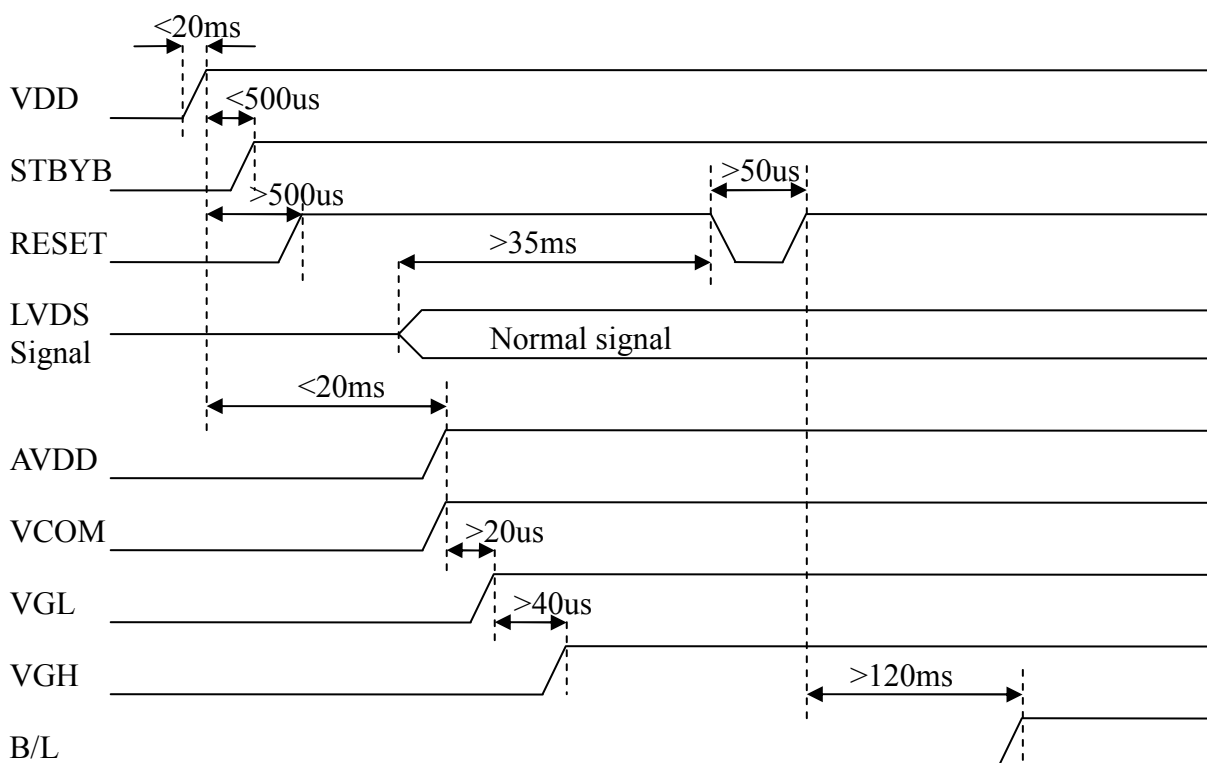

b. Power off:

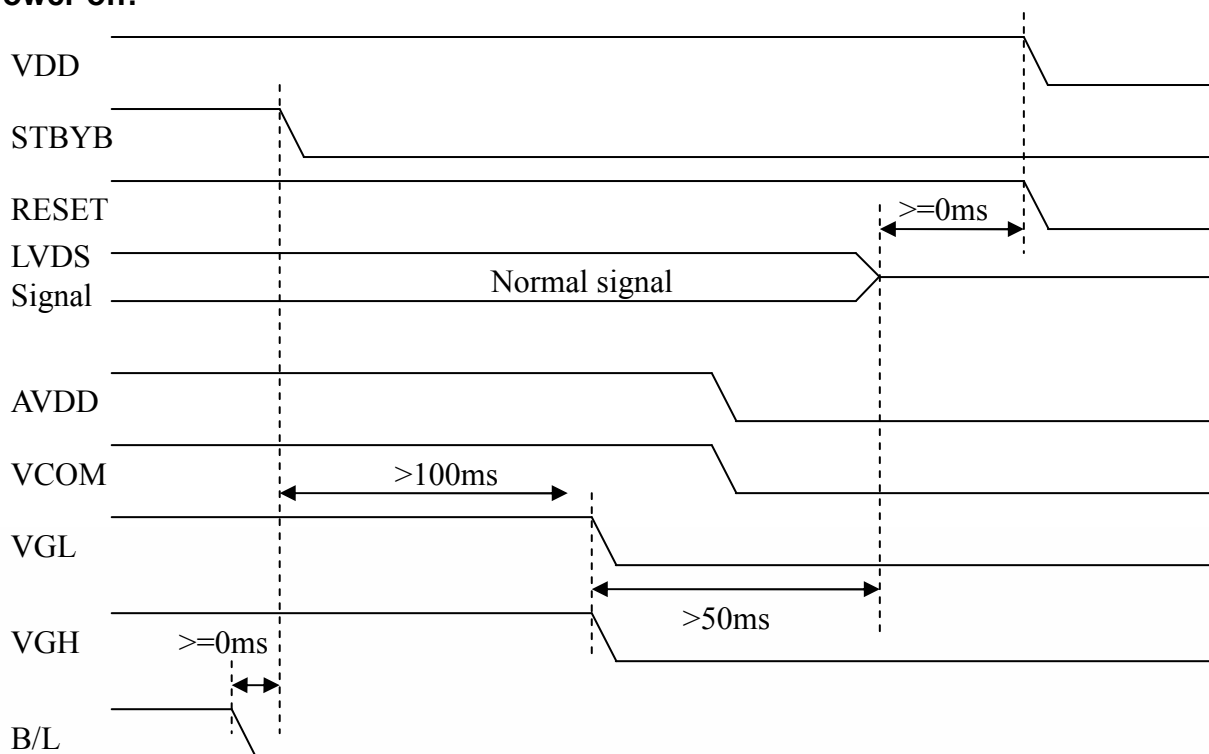

3.3. Timing Characteristics

3.3.1. AC Electrical Characteristics

Parameter	Symbol	Values			Unit	Remark
		Min.	Typ.	Max.		
Clock frequency	R_{XFCLK}	40.8	51.2	67.2	MHz	
Input data skew margin	T_{RSKM}	500	-	-	ps	
Clock high time	T_{LVCH}	-	$4/(7 * R_{XFCLK})$	-	ns	
Clock low time	T_{LVCL}	-	$3/(7 * R_{XFCLK})$	-	ns	

3.3.2. Input Clock and Data Timing Diagram

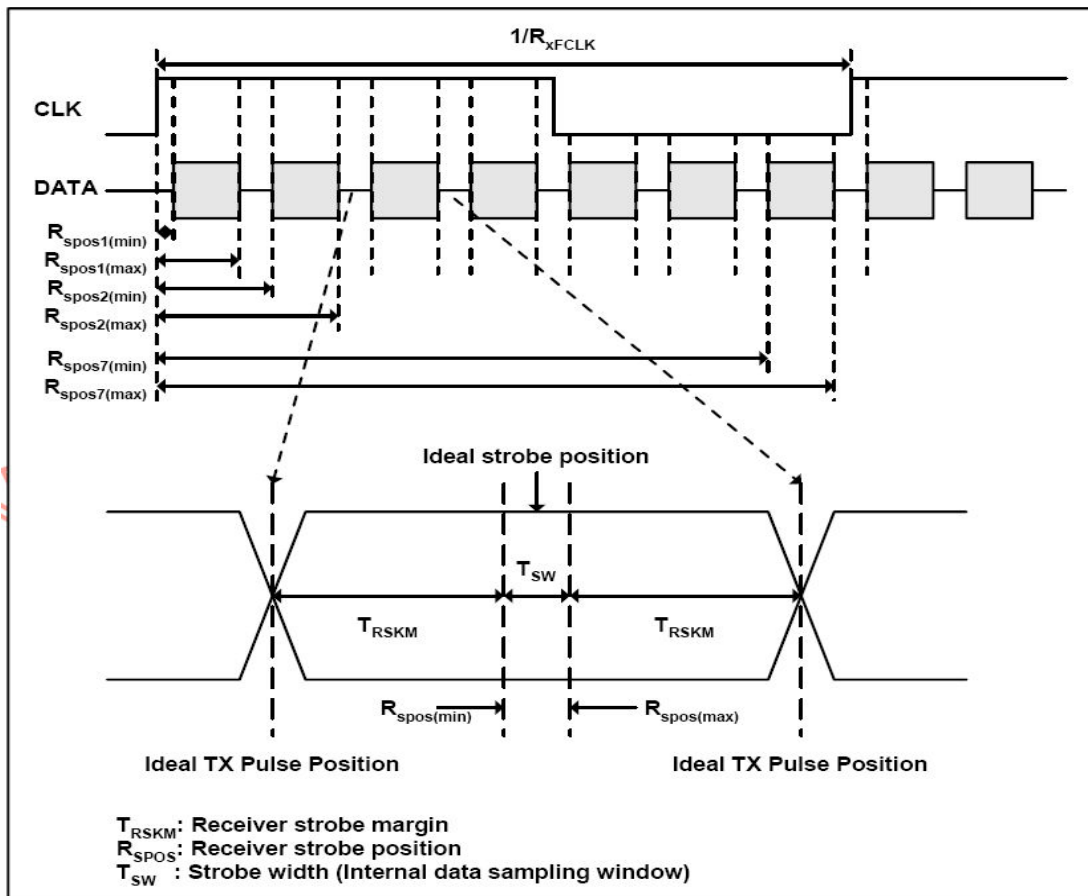
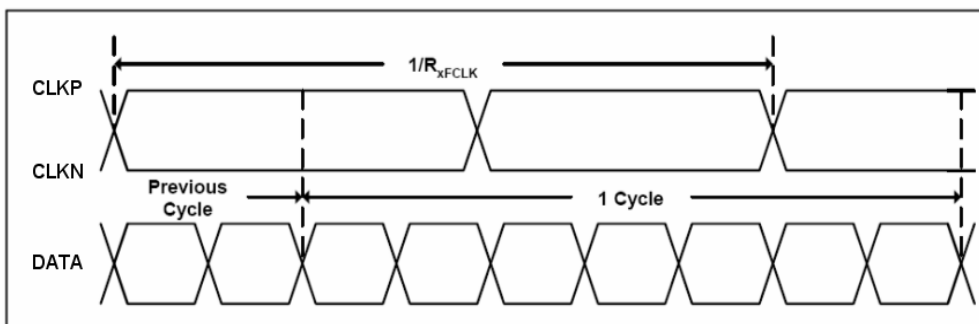

3.3.3. DC Electrical Characteristics

Parameter	Symbol	Values			Unit	Remark
		Min.	Typ.	Max.		
Differential input high Threshold voltage	R_{xVTH}	-	-	+0.1	V	$R_{xVCM}=1.2V$
Differential input low Threshold voltage	R_{xVTL}	-0.1	-	-	V	
Input voltage range (singled-end)	R_{xVIN}	0	-	2.4	V	
Differential input common mode voltage	R_{xVCM}	$ V_{ID} /2$	-	$2.4- V_{ID} /2$	V	
Differential voltage	$ V_{ID} $	0.2	-	0.6	V	
Differential input leakage current	$R_{V_{xliz}}$	-10	-	+10	μA	

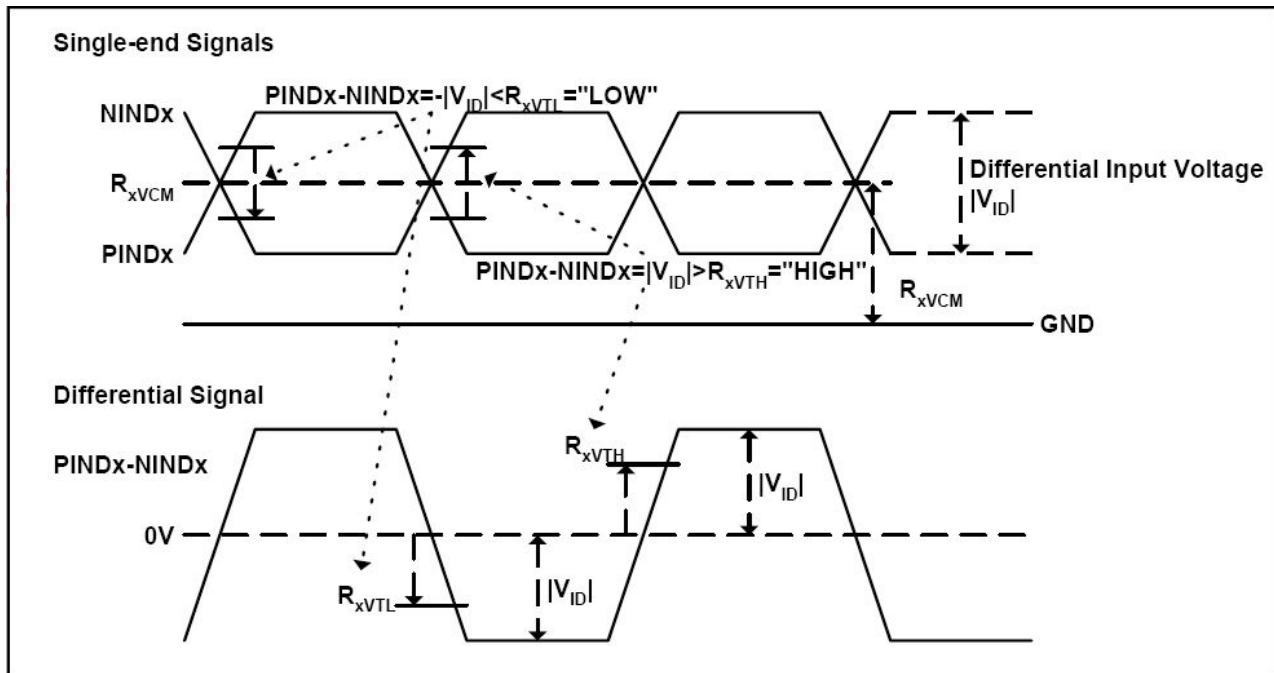

3.3.4. Timing

Item	Symbol	Values			Unit	Remark
		Min.	Typ.	Max.		
Clock Frequency	fclk	40.8	51.2	67.2	MHz	Frame rate =60Hz
Horizontal display area	thd	1024			DCLK	
HS period time	th	1114	1344	1400	DCLK	
HS Blanking	thb	90	320	376	DCLK	
Vertical display area	tvd	600			H	
VS period time	tv	610	635	800	H	
VS Blanking	thb	10	35	200	H	

3.3.5. Data Input Format

6bit LVDS input

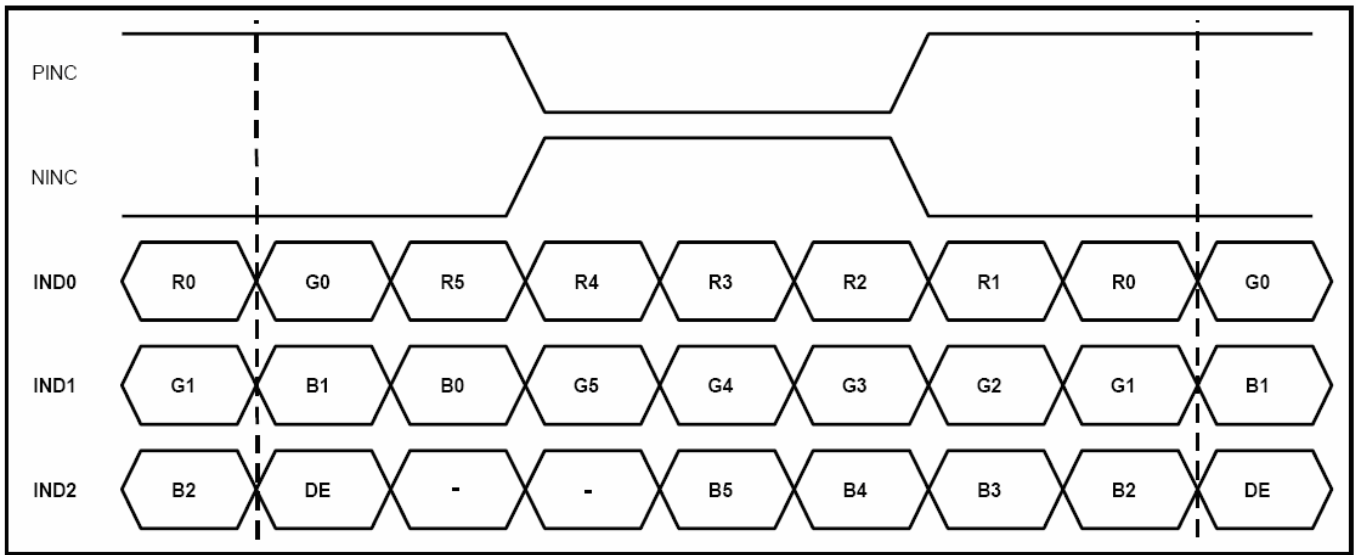

8bit LVDS input

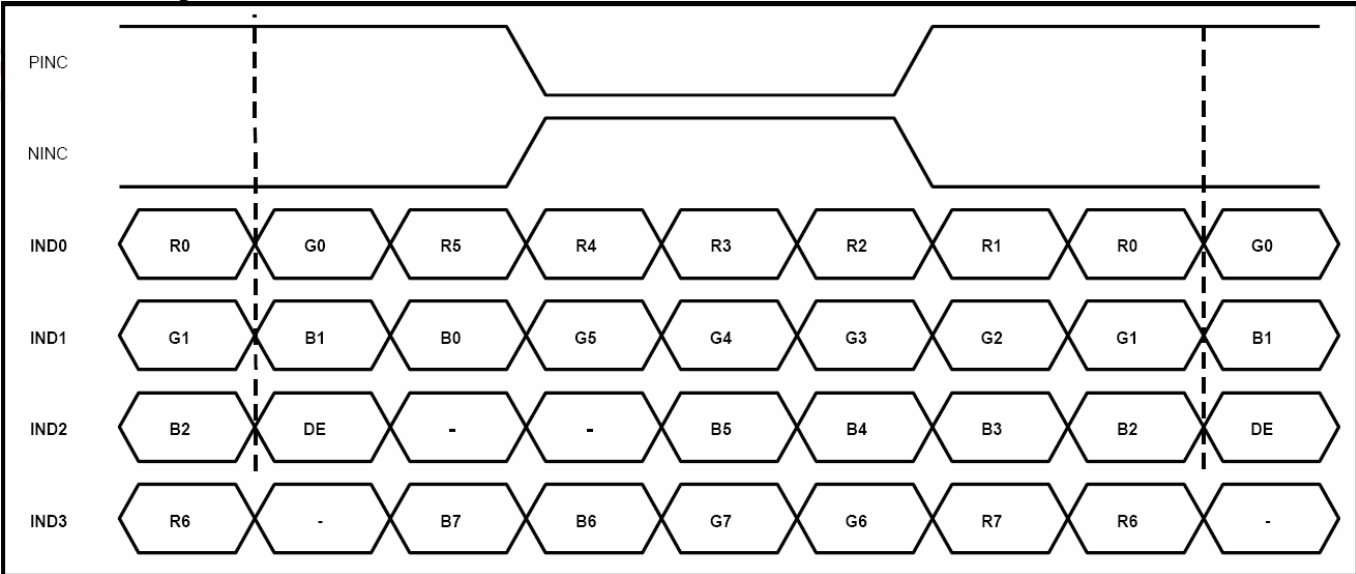

Note: Support DE timing mode only, SYNC mode not supported.

4. Optical Specifications

Item	Symbol	Condition	Values			Unit	Remark
			Min.	Typ.	Max.		
Viewing angle (CR \geq 10)	θ_L	$\Phi=180^\circ$ (9 o'clock)	65	75	-	degree	Note 1
	θ_R	$\Phi=0^\circ$ (3 o'clock)	65	75	-		
	θ_T	$\Phi=90^\circ$ (12 o'clock)	60	70	-		
	θ_B	$\Phi=270^\circ$ (6 o'clock)	65	75	-		
Response time	T_{ON}	Normal $\theta=\Phi=0^\circ$	-	10	20	msec	Note 3
	T_{OFF}		-	15	30	msec	Note 3
Contrast ratio	CR		500	700	-	-	Note 4
Color chromaticity	W_X		0.26	0.31	0.36	-	Note 2 Note 5 Note 6
	W_Y		0.28	0.33	0.38	-	Note 6
Luminance	L		200	250	-	cd/m ²	Note 6
Luminance uniformity	Y_U		70	75	-	%	Note 7

Test Conditions:

1. $DV_{DD}=3.3V$, $I_L=160mA$ (Backlight current), the ambient temperature is $25^\circ C$.
2. The test systems refer to Note 2.

Note 1: Definition of viewing angle range

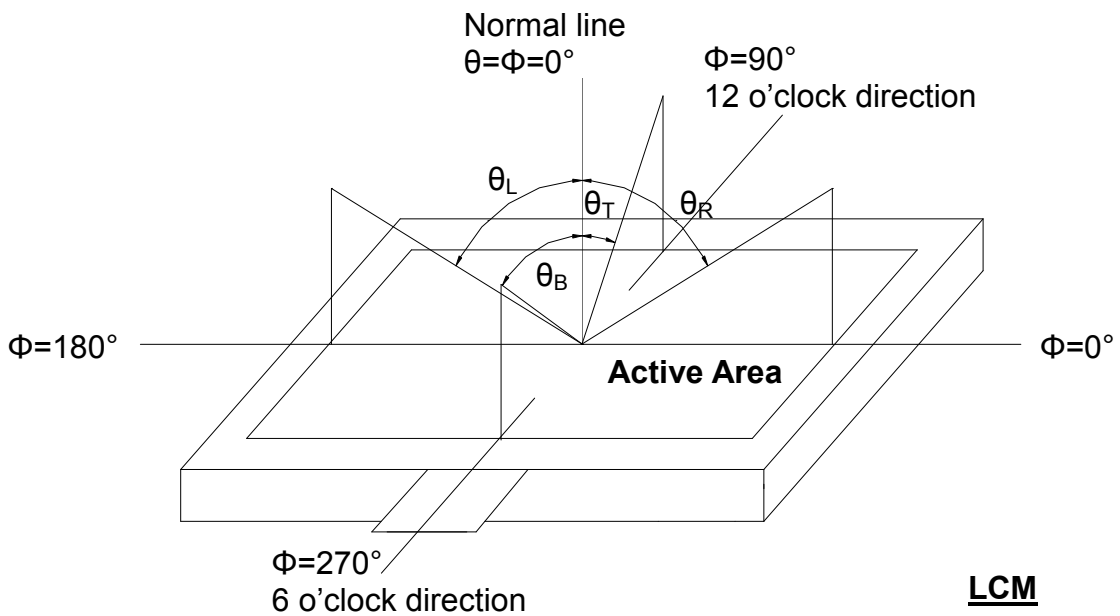

Fig. 4-1 Definition of viewing angle

Note 2: Definition of optical measurement system.

The optical characteristics should be measured in dark room. After 30 minutes operation, the optical properties are measured at the center point of the LCD screen. (Response time is measured by Photo detector TOPCON BM-7, other items are measured by BM-5A/Field of view: 1° /Height: 500mm.)

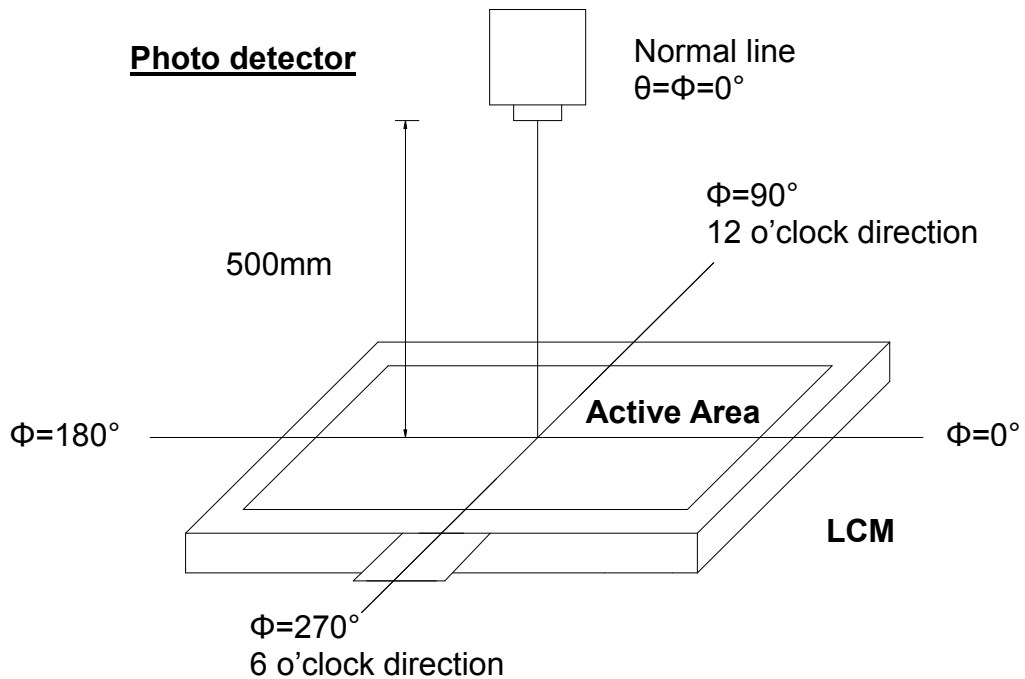

Fig. 4-2 Optical measurement system setup

Note 3: Definition of Response time

The response time is defined as the LCD optical switching time interval between “White” state and “Black” state. Rise time (T_{ON}) is the time between photo detector output intensity changed from 90% to 10%. And fall time (T_{OFF}) is the time between photo detector output intensity changed from 10% to 90%.

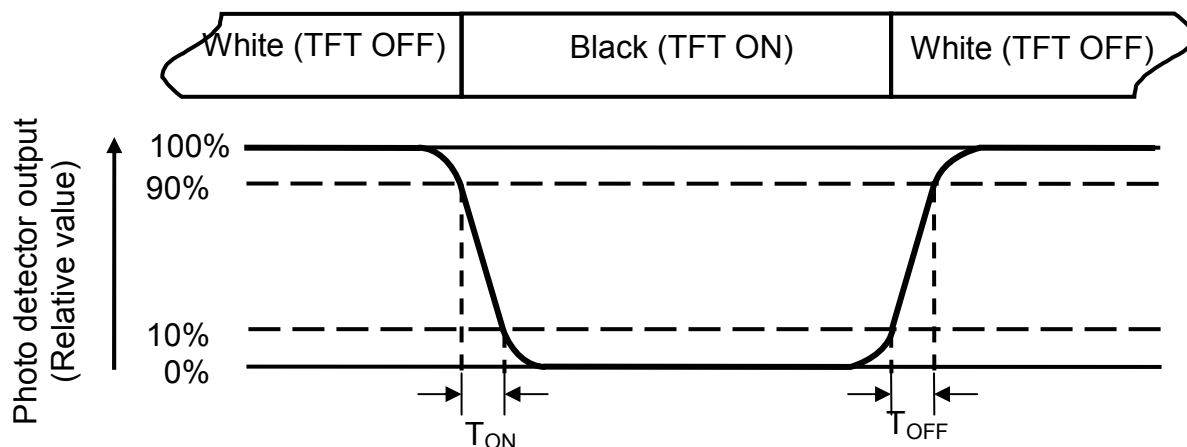

Fig. 4-3 Definition of response time

Note 4: Definition of contrast ratio

$$\text{Contrast ratio (CR)} = \frac{\text{Luminance measured when LCD on the "White" state}}{\text{Luminance measured when LCD on the "Black" state}}$$

Note 5: Definition of color chromaticity (CIE1931)

Color coordinates measured at center point of LCD.

Note 6: Definition of luminance:

Measured at the center area of the panel when LCD panel is driven at “white” state. The LED driving condition is $I_L=160\text{mA}$.

Note 7: Definition of Luminance Uniformity

Active area is divided into 9 measuring areas (Refer to Fig. 4-4).Every measuring point is placed at the center of each measuring area.

$$\text{Luminance Uniformity (Yu)} = \frac{B_{min}}{B_{max}}$$

L-----Active area length W----- Active area width

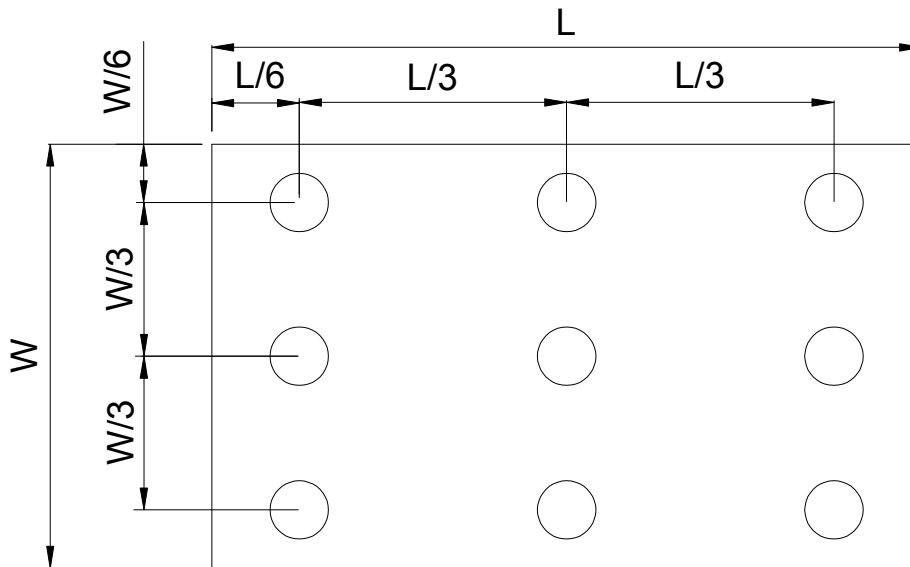

Fig. 4-4 Definition of measuring points

B_{max} : The measured maximum luminance of all measurement position.

B_{min} : The measured minimum luminance of all measurement position.

6. General Precautions

6.1. Safety

Liquid crystal is poisonous. Do not put it in your mouth. If liquid crystal touches your skin or clothes, wash it off immediately by using soap and water.

6.2. Handling

1. The LCD panel is plate glass. Do not subject the panel to mechanical shock or to excessive force on its surface.
2. The polarizer attached to the display is easily damaged. Please handle it carefully to avoid scratch or other damages.
3. To avoid contamination on the display surface, do not touch the module surface with bare hands.
4. Keep a space so that the LCD panels do not touch other components.
5. Put cover board such as acrylic board on the surface of LCD panel to protect panel from damages.
6. Transparent electrodes may be disconnected if you use the LCD panel under environmental conditions where the condensation of dew occurs.
7. Do not leave module in direct sunlight to avoid malfunction of the ICs.

6.3. Static Electricity

1. Be sure to ground module before turning on power or operating module.
2. Do not apply voltage which exceeds the absolute maximum rating value.

6.4. Storage

1. Store the module in a dark room where must keep at $25\pm 10^{\circ}\text{C}$ and 65%RH or less.
2. Do not store the module in surroundings containing organic solvent or corrosive gas.
3. Store the module in an anti-electrostatic container or bag.

6.5. Cleaning

1. Do not wipe the polarizer with dry cloth. It might cause scratch.
2. Only use a soft sloth with IPA to wipe the polarizer, other chemicals might permanent damage to the polarizer.

7. Mechanical Drawing

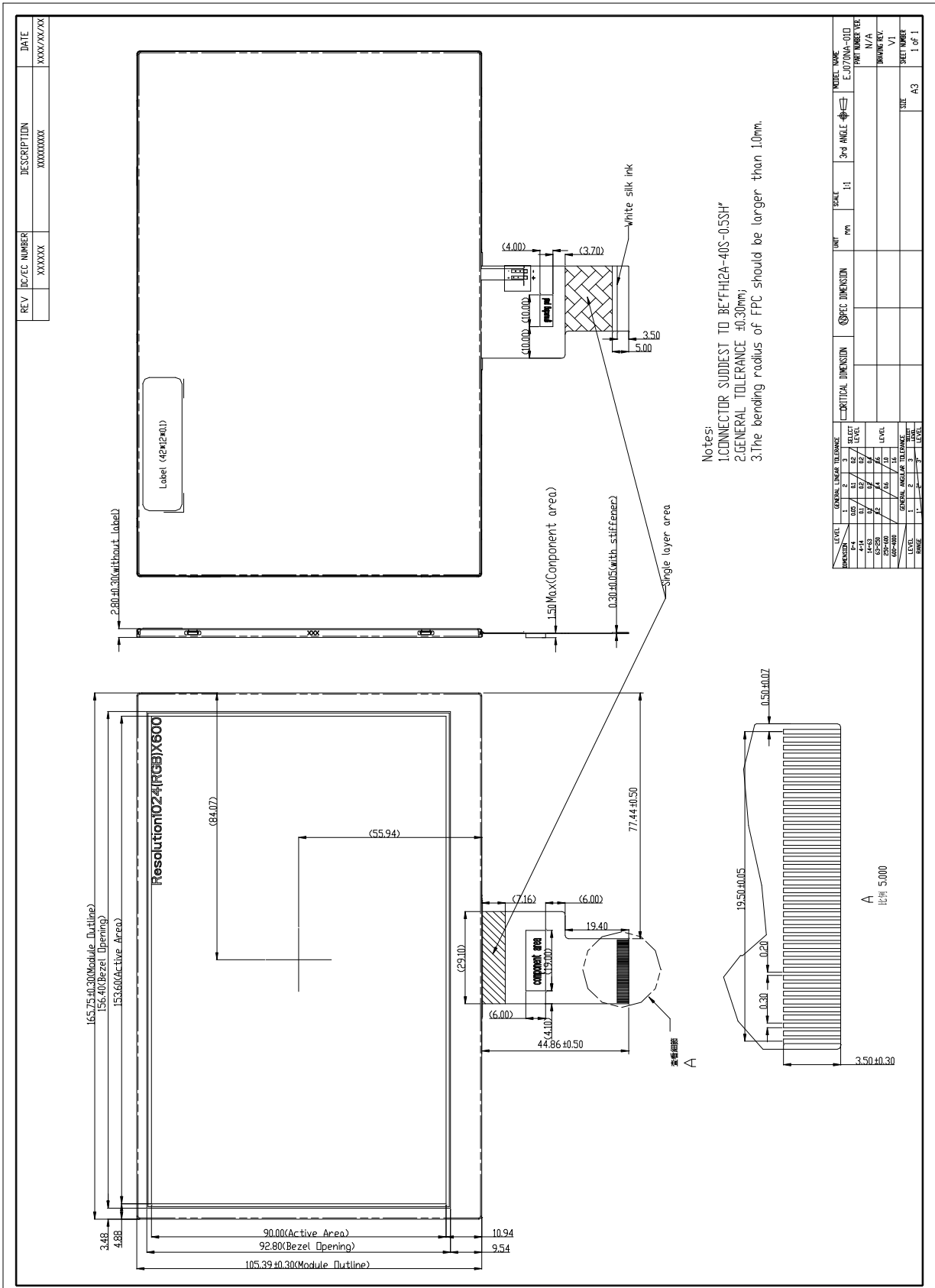

Notes:
 1.CONNECTOR SUGGEST TO BE 'FH24-40S-05SH'
 2.GENERAL TOLERANCE ±0.30mm;
 3.The bending radius of FPC should be larger than 1.0mm.

LEVEL	GENERAL TOLERANCE	UNIT	SCALE	3rd ANGLE	MODEL NAME
DESIGN	0.05	mm	1:1	☐	E:07/2016-010
4-14	0.1				PART NUMBER
15-17	0.2				DATE
18-23	0.3				1 of 1
24-25	0.4				
26-28	0.5				
29-30	0.6				
31-32	0.8				
33-34	1.0				
35-36	1.2				
37-38	1.5				
39-40	2.0				
41-42	2.5				
43-44	3.0				
45-46	4.0				
47-48	5.0				
49-50	6.0				
51-52	8.0				
53-54	10.0				
55-56	12.0				
57-58	15.0				
59-60	20.0				
61-62	25.0				
63-64	30.0				
65-66	40.0				
67-68	50.0				
69-70	60.0				
71-72	80.0				
73-74	100.0				
75-76	120.0				
77-78	150.0				
79-80	200.0				
81-82	250.0				
83-84	300.0				
85-86	400.0				
87-88	500.0				
89-90	600.0				
91-92	800.0				
93-94	1000.0				
95-96	1200.0				
97-98	1500.0				
99-100	2000.0				

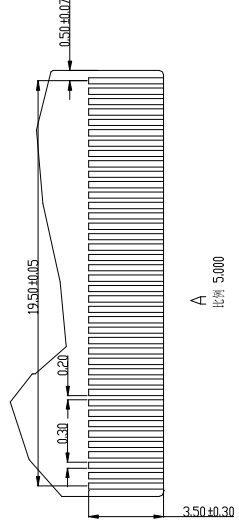

A
 1:1
 5.000

8. Package Drawing

8.1. Packaging Material Table

No.	Item	Model (Material)	Dimensions(mm)	Unit Weight (kg)	Quantity	Remark
1	LCM Module	YH070SS4001	165.75 × 105.39 × 2.8	TBD	60	
2	Partition	BC Corrugated paper	512 × 349 × 230	TBD	1set	
3	Corrugated Paper	B Corrugated paper	510 × 350	0.071	4pcs	
4	Corrugated Bar	B Corrugated paper	512 × 11 × 3	0.046	4pcs	
5	Dust-Proof Bag	PE	700 × 530	0.048	1pcs	
6	A/S Bag	PE	180 × 133 × 0.2	0.002	50pcs	
7	Carton	Corrugated paper	530 × 355 × 255	0.82	1 pcs	
8	Total weight	TBD				

8.2. Packaging Quantity

Total LCM quantity in Carton: no. of Partition	2 Rows × quantity per Row	25	= 60
--	---------------------------	----	------