



宇华国际科技有限公司
YuHua INT,L Technology Co., LIMITED

**SPECIFICATION
FOR
LCD MODULE**

Customer : _____

Product Model: YH035SD5002

Sample code: _____

| Designed by | Checked by | Approved by |
|-------------|------------|-------------|
| | | |

Final Approval by Customer

| | |
|--------------------------------------------------------------------------------------------------------------------------------------------------------|-----------------------------------------------------------------------------------------------------------------------------|
| <input type="checkbox"/> LCM Machinery OK Checked By _____ <input type="checkbox"/> LCM Display OK Checked By _____ | <input type="checkbox"/> LCM OK <input type="checkbox"/> NG , Problem survey: Approved By _____ |
|--------------------------------------------------------------------------------------------------------------------------------------------------------|-----------------------------------------------------------------------------------------------------------------------------|

※The specification of “TBD” should refer to the measured value of sample . If there is difference between the design specification and measured value, we naturally shall negotiate and agree to solution with customer.

Contents

| | |
|--------------------------------------------------|----|
| 1. General Specifications | 1 |
| 2. Pin Assignment | 2 |
| 3. Operation Specifications | 5 |
| 3.1. Absolute Maximum Ratings | 5 |
| 3.1.1. Typical Operation Conditions | 6 |
| 3.1.2. Current Consumption | 7 |
| 3.1.3. Backlight Driving Conditions | 7 |
| 3.2. Power Sequence | 8 |
| 3.3. Timing Characteristics | 9 |
| 3.3.1. AC Electrical Characteristics | 9 |
| 3.3.2. Input Clock and Data Timing Diagram | 9 |
| 3.3.3. Timing | 10 |
| 3.3.4. Data Input Format | 11 |
| 4. Optical Specifications | 12 |
| 5. Reliability Test Items | 16 |
| 6. General Precautions | 17 |
| 6.1. Safety | 17 |
| 6.2. Handling | 17 |
| 6.3. Static Electricity | 17 |
| 6.4. Storage | 17 |
| 6.5. Cleaning | 17 |
| 7. Mechanical Drawing | 18 |
| 8. Package Drawing | 19 |
| 8.1. Packaging Material Table | 19 |
| 8.2. Packaging Quantity | 19 |
| 8.3. Packaging Drawing | 20 |

1. General Specifications

| No. | Item | Specification | Remark |
|-----|-----------------------------|---------------------------------|--------|
| 1 | LCD size | 7.0 inch(Diagonal) | |
| 2 | Driver element | a-Si TFT active matrix | |
| 3 | Resolution | 800 × 3(RGB) × 480 | |
| 4 | Display mode | Normally White, Transmissive | |
| 5 | Dot pitch | 0.0642(W) × 0.1790(H) mm | |
| 6 | Active area | 154.08(W) × 85.92(H) mm | |
| 7 | Module size | 164.9(W) × 100.0(H) × 5.5(D) mm | Note 1 |
| 8 | Surface treatment | Anti-Glare | |
| 9 | Color arrangement | RGB-stripe | |
| 10 | Interface | Digital | |
| 11 | Backlight power consumption | 1.674W (Typ.) | |
| 12 | Panel power consumption | 0.226W (Typ.) | |
| 13 | Weight | 150g (Typ.) | |

Note 1: Refer to Mechanical Drawing.

2. Pin Assignment

FPC Connector is used for the module electronics interface. The recommended model is FH12A-50S-0.5SH manufactured by Hirose.

| Pin No. | Symbol | I/O | Function | Remark |
|---------|-------------------|-----|-----------------------------------|--------|
| 1 | V _{LED+} | P | Power for LED backlight (Anode) | |
| 2 | V _{LED+} | P | Power for LED backlight (Anode) | |
| 3 | V _{LED-} | P | Power for LED backlight (Cathode) | |
| 4 | V _{LED-} | P | Power for LED backlight (Cathode) | |
| 5 | GND | P | Power ground | |
| 6 | V _{COM} | I | Common voltage | |
| 7 | DV _{DD} | P | Power for Digital Circuit | |
| 8 | MODE | I | DE/SYNC mode select | Note 1 |
| 9 | DE | I | Data Input Enable | |
| 10 | VS | I | Vertical Sync Input | |
| 11 | HS | I | Horizontal Sync Input | |
| 12 | B7 | I | Blue data(MSB) | |
| 13 | B6 | I | Blue data | |
| 14 | B5 | I | Blue data | |
| 15 | B4 | I | Blue data | |
| 16 | B3 | I | Blue data | |
| 17 | B2 | I | Blue data | |
| 18 | B1 | I | Blue data | Note 2 |
| 19 | B0 | I | Blue data(LSB) | Note 2 |
| 20 | G7 | I | Green data(MSB) | |
| 21 | G6 | I | Green data | |
| 22 | G5 | I | Green data | |
| 23 | G4 | I | Green data | |
| 24 | G3 | I | Green data | |
| 25 | G2 | I | Green data | |
| 26 | G1 | I | Green data | Note 2 |

| | | | | |
|----|------------------|---|--------------------------|----------|
| 27 | G0 | I | Green data(LSB) | Note 2 |
| 28 | R7 | I | Red data(MSB) | |
| 29 | R6 | I | Red data | |
| 30 | R5 | I | Red data | |
| 31 | R4 | I | Red data | |
| 32 | R3 | I | Red data | |
| 33 | R2 | I | Red data | |
| 34 | R1 | I | Red data | Note 2 |
| 35 | R0 | I | Red data(LSB) | Note 2 |
| 36 | GND | P | Power Ground | |
| 37 | DCLK | I | Sample clock | Note 3 |
| 38 | GND | P | Power Ground | |
| 39 | L/R | I | Left / right selection | Note 4,5 |
| 40 | U/D | I | Up/down selection | Note 4,5 |
| 41 | V _{GH} | P | Gate ON Voltage | |
| 42 | V _{GL} | P | Gate OFF Voltage | |
| 43 | AV _{DD} | P | Power for Analog Circuit | |
| 44 | RESET | I | Global reset pin. | Note 6 |
| 45 | NC | - | No connection | |
| 46 | V _{COM} | I | Common Voltage | |
| 47 | DITHB | I | Dithering function | Note 7 |
| 48 | GND | P | Power Ground | |
| 49 | NC | - | No connection | |
| 50 | NC | - | No connection | |

I: input, O: output, P: Power

Note 1: DE/SYNC mode select. Normally pull high.

When select DE mode, MODE="1", VS and HS must pull high.

When select SYNC mode, MODE="0", DE must be grounded.

Note 2: When input 18 bits RGB data, the two low bits of R,G and B data must be grounded.

Note 3: Data shall be latched at the falling edge of DCLK.

Note 4: Selection of scanning mode

| Setting of scan control input | | Scanning direction |
|-------------------------------|------------------|---------------------------|
| U/D | L/R | |
| GND | DV _{DD} | Up to down, left to right |
| DV _{DD} | GND | Down to up, right to left |
| GND | GND | Up to down, right to left |
| DV _{DD} | DV _{DD} | Down to up, left to right |

Note 5: Definition of scanning direction.
Refer to the figure as below:

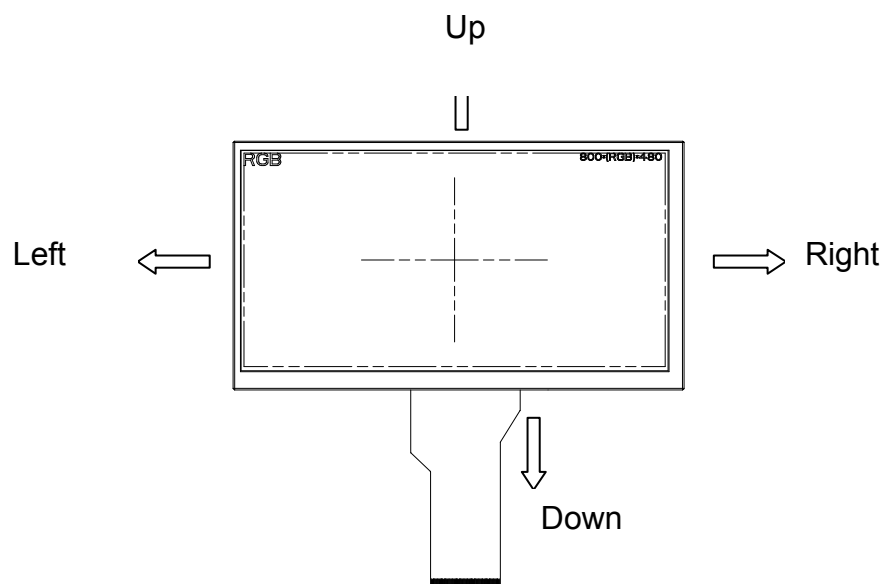

Note 6: Global reset pin. Active low to enter reset state. Suggest to connect with an RC reset circuit for stability. Normally pull high.

Note 7: Dithering function enable control, normally pull high.
When DITHB="1", Disable internal dithering function,
When DITHB="0", Enable internal dithering function,

3. Operation Specifications

3.1. Absolute Maximum Ratings

(Note 1)

| Item | Symbol | Values | | Unit | Remark |
|-----------------------|-----------------|--------|------|------|--------------------|
| | | Min. | Max. | | |
| Power voltage | DV_{DD} | -0.3 | 5.0 | V | |
| | AV_{DD} | 6.5 | 13.5 | V | |
| | V_{GH} | -0.3 | 40.0 | V | |
| | V_{GL} | -20.0 | 0.3 | V | |
| | $V_{GH}-V_{GL}$ | - | 40.0 | V | |
| Operation Temperature | T_{OP} | -30 | 85 | °C | |
| Storage Temperature | T_{ST} | -30 | 85 | °C | |
| LED Reverse Voltage | V_R | - | 1.2 | V | Each LED Note 2 |
| LED Forward Current | I_F | - | 25 | mA | Each LED |

Note 1: The absolute maximum rating values of this product are not allowed to be exceeded at any times. Should a module be used with any of the absolute maximum ratings exceeded, the characteristics of the module may not be recovered, or in an extreme case, the module may be permanently destroyed.

Note 2: V_R Conditions: Zener Diode 20mA

3.1.1. Typical Operation Conditions

(Note 1)

| Item | Symbol | Values | | | Unit | Remark |
|--------------------------|-----------|---------------|------|---------------|------|--------|
| | | Min. | Typ. | Max. | | |
| Power voltage | DV_{DD} | 3.0 | 3.3 | 3.6 | V | Note 2 |
| | AV_{DD} | 10.2 | 10.4 | 10.6 | V | |
| | V_{GH} | 15.3 | 16.0 | 16.7 | V | |
| | V_{GL} | -7.7 | -7.0 | -6.3 | V | |
| Input signal voltage | V_{COM} | 3.6 | 3.8 | 4.0 | V | |
| Input logic high voltage | V_{IH} | 0.7 DV_{DD} | - | DV_{DD} | V | Note 3 |
| Input logic low voltage | V_{IL} | 0 | - | 0.3 DV_{DD} | V | |

Note 1: Be sure to apply DV_{DD} and V_{GL} to the LCD first, and then apply V_{GH} .

Note 2: DV_{DD} setting should match the signals output voltage (refer to Note 3) of customer's system board.

Note 3: DCLK,HS,VS,RESET,U/D, L/R,DE,R0~R7,G0~G7,B0~B7,MODE,DITHB.

3.1.2. Current Consumption

| Item | Symbol | Values | | | Unit | Remark |
|--------------------|---------------|--------|------|------|------|-------------------|
| | | Min. | Typ. | Max. | | |
| Current for Driver | I_{GH} | - | 0.2 | 1.0 | mA | $V_{GH} = 16.0V$ |
| | I_{GL} | - | 0.2 | 1.0 | mA | $V_{GL} = -7.0V$ |
| | IDV_{DD} | - | 4.0 | 10 | mA | $DV_{DD} = 3.3V$ |
| | $I_{AV_{DD}}$ | - | 20 | 50 | mA | $AV_{DD} = 10.4V$ |

3.1.3. Backlight Driving Conditions

| Item | Symbol | Values | | | Unit | Remark |
|---------------------------|--------|--------|------|------|------|--------|
| | | Min. | Typ. | Max. | | |
| Voltage for LED backlight | V_L | 8.4 | 9.3 | 10.2 | V | Note 1 |
| Current for LED backlight | I_L | 80 | 100 | 120 | mA | |
| LED life time | - | 20,000 | - | - | Hr | Note 2 |

Note 1: The LED Supply Voltage is defined by the number of LED at $T_a = 25^\circ C$ and $I_L = 100mA$.

Note 2: The "LED life time" is defined as the module brightness decrease to 50% original brightness at $T_a = 25^\circ C$ and $I_L = 100mA$. The LED lifetime could be decreased if operating I_L is larger than 100mA.

3.2. Power Sequence

a. Power on:

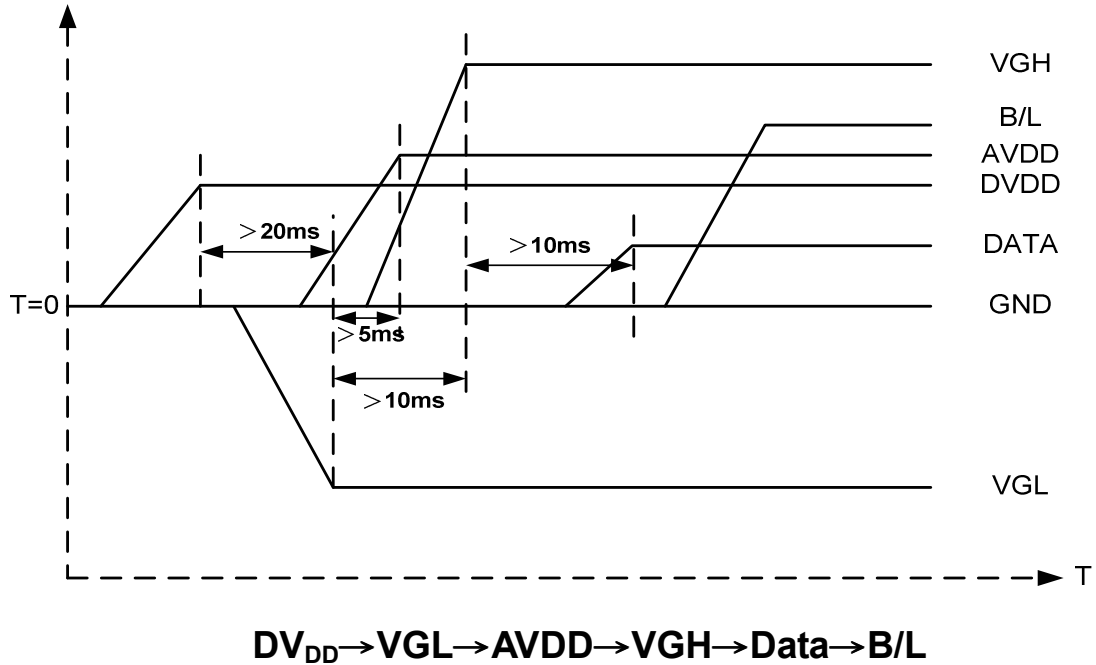

b. Power off:

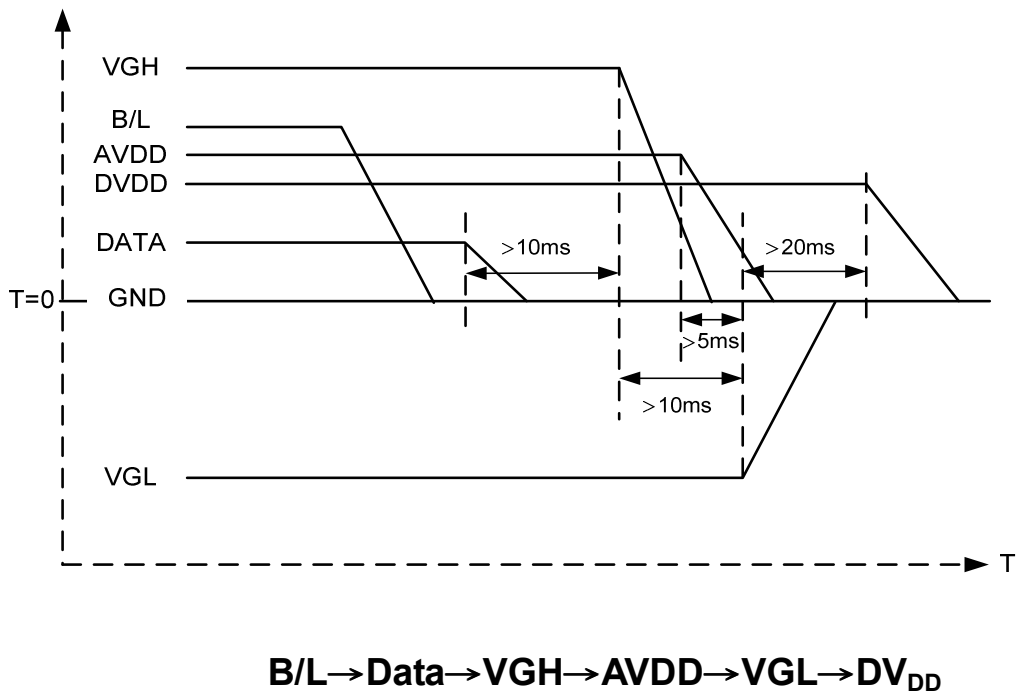

Note: Data include R0~R7, B0~B7, GO~G7, U/D, L/R, DCLK, HS,VS,DE.

3.3. Timing Characteristics

3.3.1. AC Electrical Characteristics

| Item | Symbol | Values | | | Unit | Remark |
|-------------------------------------|-----------|--------|------|------|------|--------------------------------|
| | | Min. | Typ. | Max. | | |
| HS setup time | T_{hst} | 8 | - | - | ns | |
| HS hold time | T_{hhd} | 8 | - | - | ns | |
| VS setup time | T_{vst} | 8 | - | - | ns | |
| VS hold time | T_{vhd} | 8 | - | - | ns | |
| Data setup time | T_{dsu} | 8 | - | - | ns | |
| Data hole time | T_{dhd} | 8 | - | - | ns | |
| DE setup time | T_{esu} | 8 | - | - | ns | |
| DE hole time | T_{ehd} | 8 | - | - | ns | |
| DV _{DD} Power On Slew rate | T_{POR} | - | - | 20 | ms | From 0 to 90% DV _{DD} |
| RESET pulse width | T_{Rst} | 1 | - | - | ms | |
| DCLK cycle time | T_{coh} | 20 | - | - | ns | |
| DCLK pulse duty | T_{cwh} | 40 | 50 | 60 | % | |

3.3.2. Input Clock and Data Timing Diagram

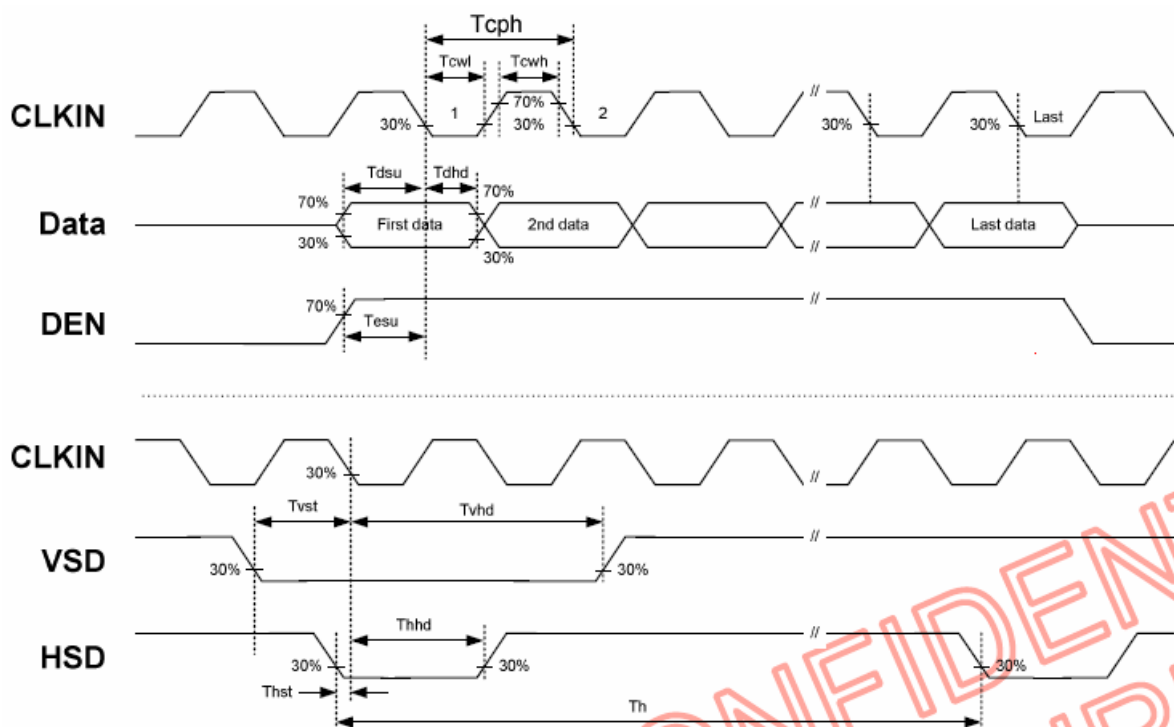

3.3.3. Timing

| Item | Symbol | Values | | | Unit | Remark |
|-------------------------|--------|--------|------|------|------|--------|
| | | Min. | Typ. | Max. | | |
| Horizontal Display Area | thd | - | 800 | - | DCLK | |
| DCLK Frequency | fclk | 26.4 | 33.3 | 46.8 | MHz | |
| One Horizontal Line | th | 862 | 1056 | 1200 | DCLK | |
| HS pulse width | thpw | 1 | - | 40 | DCLK | |
| HS Blanking | thb | 46 | 46 | 46 | DCLK | |
| HS Front Porch | thfp | 16 | 210 | 354 | DCLK | |

| Item | Symbol | Values | | | Unit | Remark |
|-----------------------|--------|--------|------|------|------|--------|
| | | Min. | Typ. | Max. | | |
| Vertical Display Area | tvd | - | 480 | - | TH | |
| VS period time | tv | 510 | 525 | 650 | TH | |
| VS pulse width | tvpw | 1 | - | 20 | TH | |
| VS Blanking | tvb | 23 | 23 | 23 | TH | |
| VS Front Porch | tvfp | 7 | 22 | 147 | TH | |

3.3.4. Data Input Format

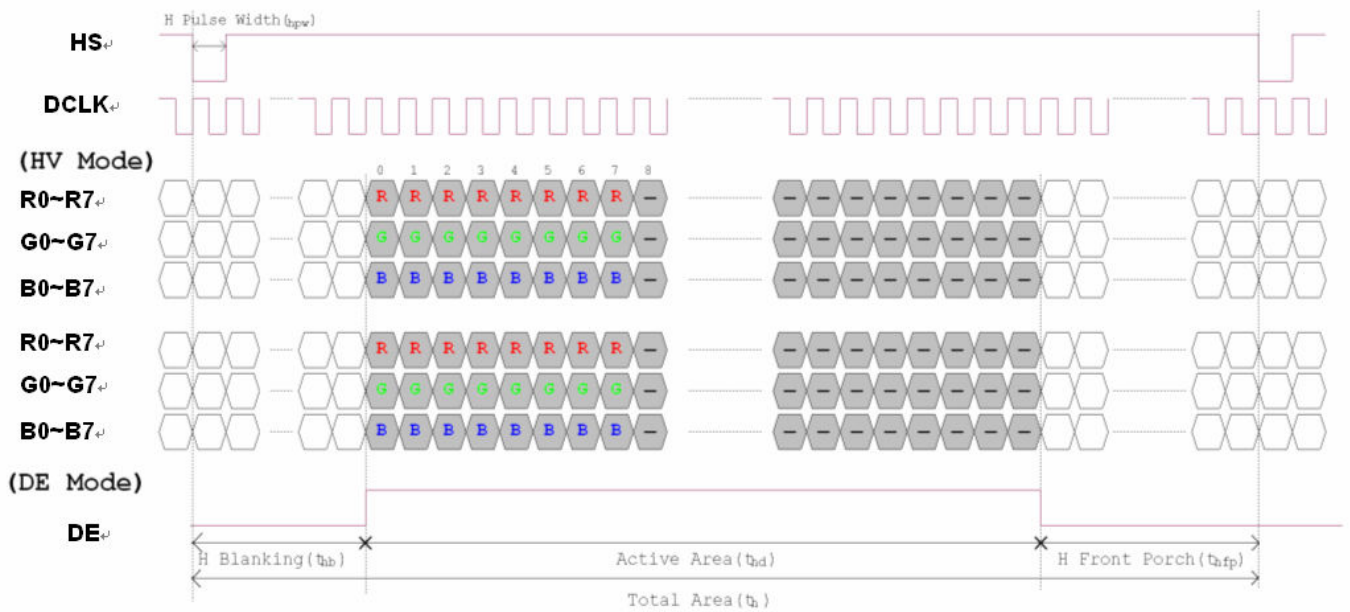

Figure 3. 1 Horizontal input timing diagram.

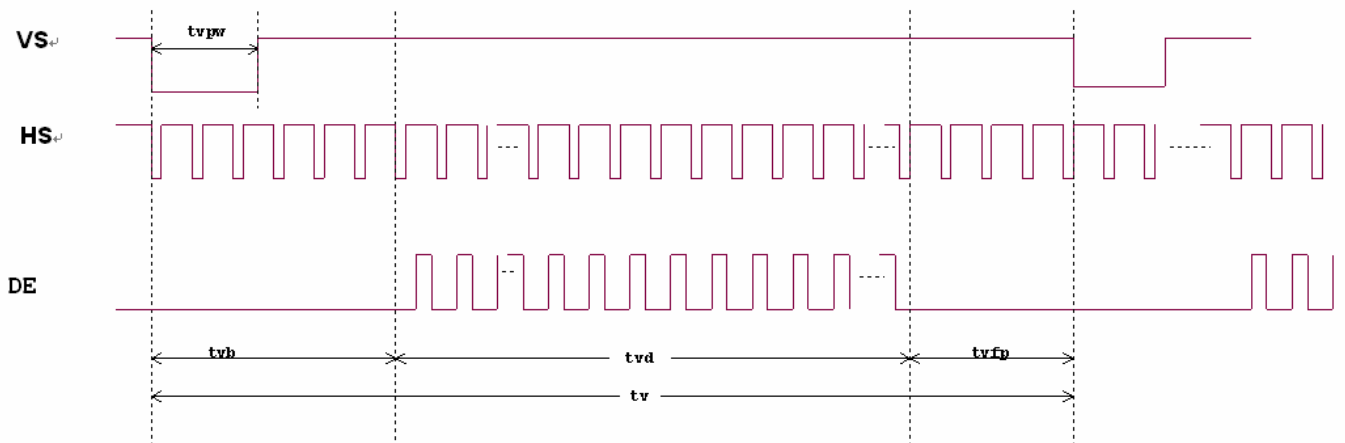

Figure 3. 2 Vertical input timing diagram.

4. Optical Specifications

| Item | Symbol | Condition | Values | | | Unit | Remark |
|---------------------------|------------|---------------------------------|--------|------|------|-------------------|------------------|
| | | | Min. | Typ. | Max. | | |
| Viewing angle (CR≥ 10) | θ_L | $\Phi=180^\circ$ (9 o'clock) | 60 | 70 | - | degree | Note 1 |
| | θ_R | $\Phi=0^\circ$ (3 o'clock) | 60 | 70 | - | | |
| | θ_T | $\Phi=90^\circ$ (12 o'clock) | 40 | 50 | - | | |
| | θ_B | $\Phi=270^\circ$ (6 o'clock) | 60 | 70 | - | | |
| Response time | T_{ON} | Normal $\theta=\Phi=0^\circ$ | - | 10 | 20 | msec | Note 3 |
| | T_{OFF} | | - | 15 | 30 | msec | Note 3 |
| Contrast ratio | CR | | 400 | 500 | - | - | Note 4 |
| Color chromaticity | W_X | | 0.26 | 0.31 | 0.36 | - | Note 2 Note 5 |
| | W_Y | | 0.28 | 0.33 | 0.38 | - | Note 6 |
| Luminance | L | | - | 250 | - | cd/m ² | Note 6 |
| Luminance uniformity | Y_U | | 70 | 75 | - | % | Note 7 |

Test Conditions:

1. $DV_{DD}=3.3V$, $I_L=100mA$ (Backlight current), the ambient temperature is $25^\circ C$.
2. The test systems refer to Note 2.

Note 1: Definition of viewing angle range

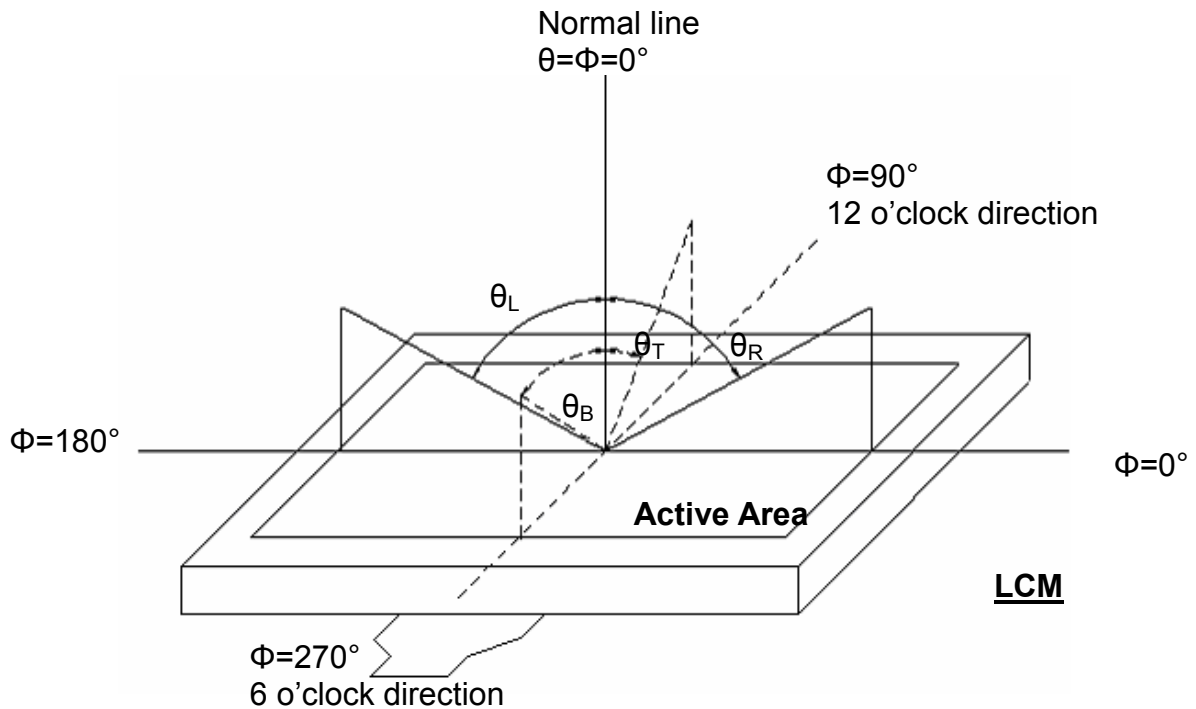

Fig. 4-1 Definition of viewing angle

Note 2: Definition of optical measurement system.

The optical characteristics should be measured in dark room. After 30 minutes operation, the optical properties are measured at the center point of the LCD screen. (Response time is measured by Photo detector TOPCON BM-7, other items are measured by BM-5A/Field of view: 1° /Height: 500mm.)

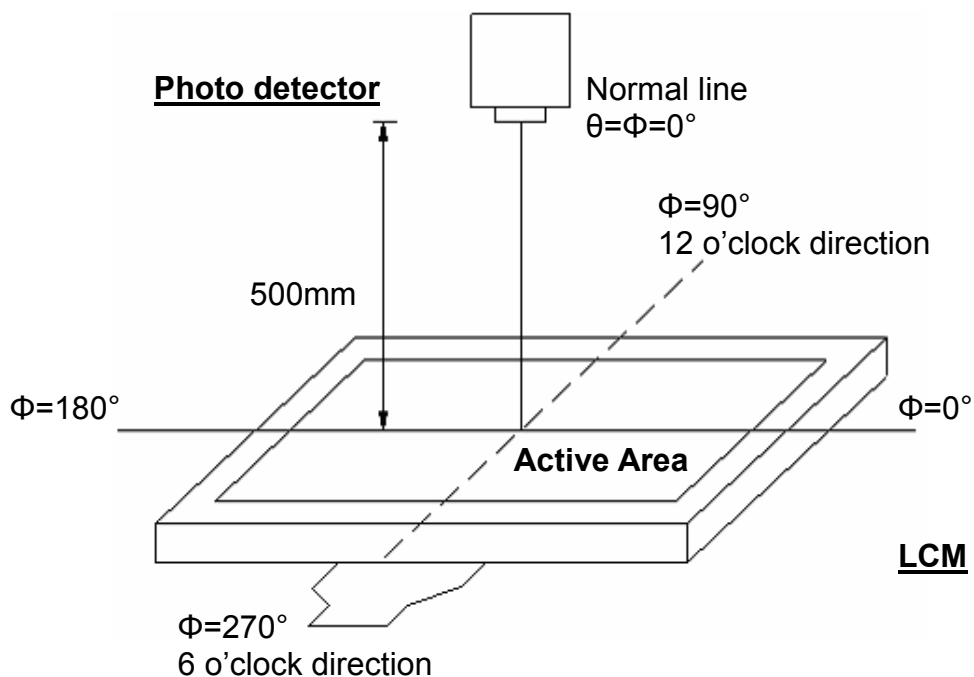

Fig. 4-2 Optical measurement system setup

Note 3: Definition of Response time

The response time is defined as the LCD optical switching time interval between "White" state and "Black" state. Rise time (T_{ON}) is the time between photo detector output intensity changed from 90% to 10%. And fall time (T_{OFF}) is the time between photo detector output intensity changed from 10% to 90%.

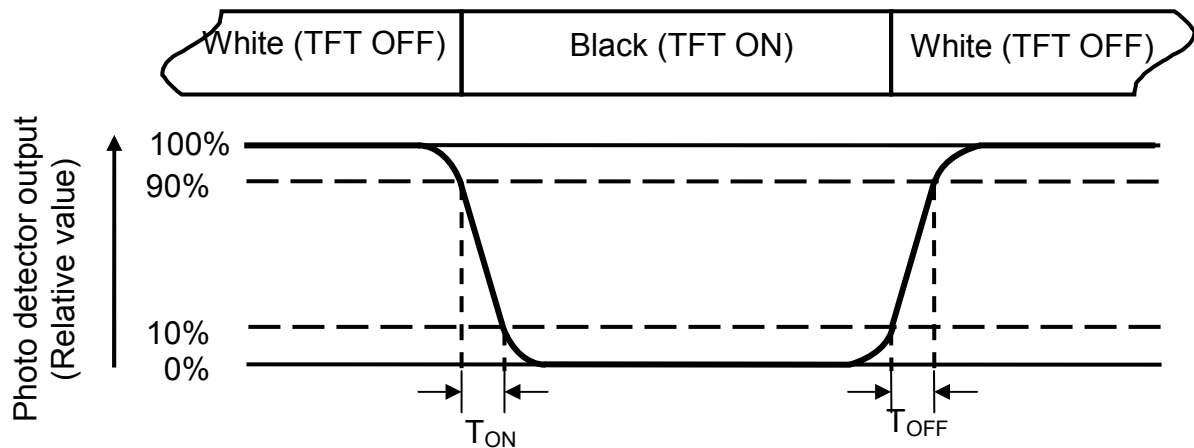

Fig. 4-3 Definition of response time

Note 4: Definition of contrast ratio

$$\text{Contrast ratio (CR)} = \frac{\text{Luminance measured when LCD on the "White" state}}{\text{Luminance measured when LCD on the "Black" state}}$$

Note 5: Definition of color chromaticity (CIE1931)

Color coordinates measured at center point of LCD.

Note 6: All input terminals LCD panel must be ground while measuring the center area of the panel. The LED driving condition is $I_L=100\text{mA}$.

Note 7: Definition of Luminance Uniformity

Active area is divided into 9 measuring areas (Refer to Fig. 4-4).Every measuring point is placed at the center of each measuring area.

$$\text{Luminance Uniformity (Yu)} = \frac{B_{min}}{B_{max}}$$

L-----Active area length W----- Active area width

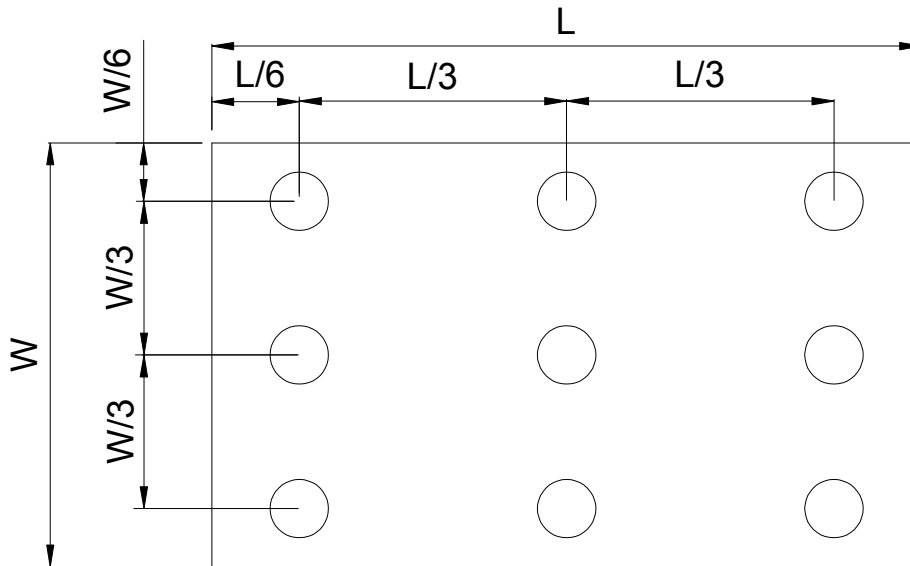

Fig. 4-4 Definition of measuring points

B_{max} : The measured maximum luminance of all measurement position.

B_{min} : The measured minimum luminance of all measurement position.

6. General Precautions

6.1. Safety

Liquid crystal is poisonous. Do not put it in your mouth. If liquid crystal touches your skin or clothes, wash it off immediately by using soap and water.

6.2. Handling

1. The LCD panel is plate glass. Do not subject the panel to mechanical shock or to excessive force on its surface.
2. The polarizer attached to the display is easily damaged. Please handle it carefully to avoid scratch or other damages.
3. To avoid contamination on the display surface, do not touch the module surface with bare hands.
4. Keep a space so that the LCD panels do not touch other components.
5. Put cover board such as acrylic board on the surface of LCD panel to protect panel from damages.
6. Transparent electrodes may be disconnected if you use the LCD panel under environmental conditions where the condensation of dew occurs.
7. Do not leave module in direct sunlight to avoid malfunction of the ICs.

6.3. Static Electricity

1. Be sure to ground module before turning on power or operating module.
2. Do not apply voltage which exceeds the absolute maximum rating value.

6.4. Storage

1. Store the module in a dark room where must keep at $25\pm 10^{\circ}\text{C}$ and 65%RH or less.
2. Do not store the module in surroundings containing organic solvent or corrosive gas.
3. Store the module in an anti-electrostatic container or bag.

6.5. Cleaning

1. Do not wipe the polarizer with dry cloth. It might cause scratch.
2. Only use a soft sloth with IPA to wipe the polarizer, other chemicals might permanent damage to the polarizer.

8. Package Drawing

8.1. Packaging Material Table

| No. | Item | Model (Material) | Dimensions(mm) | Unit Weight (kg) | Quantity | Remark |
|-----|------------------|---------------------|---------------------|------------------|----------|--------|
| 1 | LCM Module | YH070SD5002 | 164.9 × 100.0 × 5.5 | 0.150 | 60pcs | |
| 2 | Partition | BC Corrugated paper | 512 × 349 × 226 | 1.466 | 1set | |
| 3 | Corrugated Paper | B Corrugated paper | 510 × 350 | 0.071 | 4pcs | |
| 4 | Corrugated Bar | B Corrugated paper | 512 × 11 × 3 | 0.046 | 4pcs | |
| 5 | Dust-Proof Bag | PE | 700 × 530 | 0.048 | 1pcs | |
| 6 | A/S Bag | PE 180 × 133 × 0.2 | 0.002 60 | pcs | | |
| 7 | Carton | Corrugated paper | 530 × 355 × 255 | 1.100 | 1 pcs | |
| 8 | Total weight | 10.682 kg ± 5% | | | | |

8.2. Packaging Quantity

| | | |
|------------------------------------------------|------------------------------|------|
| Total LCM quantity in Carton: no. of Partition | 2 Rows × quantity per Row 30 | = 60 |
|------------------------------------------------|------------------------------|------|

8.3. Packaging Drawing

